



Circular Outward ø600 Surface

Benedito Design

Pendant Circular Outward ø600 Surface LED 39 LED neutral-white 4000K ON-OFF Black 3674lm

Technical features

- Luminaire total power: 39W
- Real lumens: 3674
- Real lm/W: 94
- Correlated Colour Temperature (CCT): LED neutral-white 4000K
- UGR: <=22
- Structure finish: Black
- Diffuser material: Polycarbonate
- Diffuser finish: Opal
- Driver Brand: INVENTRONICS
- Voltage / frequency: 100-240V/50-60Hz
- Dimming protocol: ON-OFF/DALI
- Power Factor: 0.90
- Useful life: 50,000h L80B20
- Warranty: 5 años



Luminotechnic features

CRI: 90

UGR		Lampholder	Quantity	Light source power (W)	Correlated Colour Temperature (CCT)
S=0.250					
Ceiling / cavity	0.7	LED	1	36.4W	LED neutral-white 4000K
Walls	0.5				
Working Plane	0.2				
Room dimensions	X=4H, Y=8H				
UGR crosswise	21.9				
UGR lengthwise	21.6				

- Net weight (kg): 3.4
- Packaged weight (kg): 5.42
- Packaging: 700mm x 695mm x 100mm

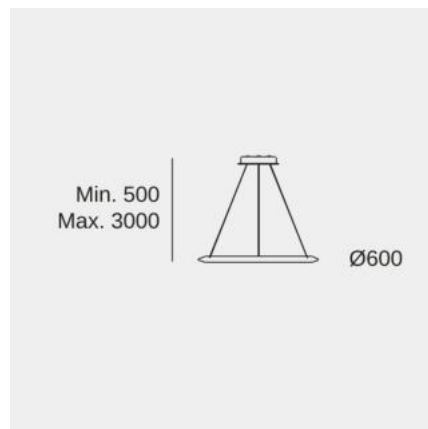
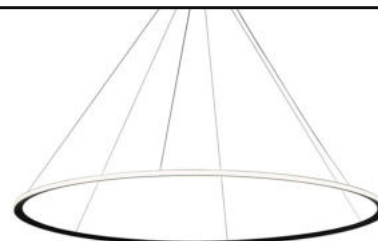

Image may not match reference. LedsC4 reserves the right to amend any of the product's components. The data related to flux, power and colour temperature may be subject to changes made by the manufacturer.



Circular Outward ø900 Surface

Benedito Design

Pendant Circular Outward ø900 Surface LED 53 LED neutral-white 4000K ON-OFF Black 4159lm

Technical features

- Luminaire total power: 53W
- Real lumens: 4159
- Real lm/W: 78
- Correlated Colour Temperature (CCT): LED neutral-white 4000K
- UGR: <=19
- Structure finish: Black
- Diffuser material: Polycarbonate
- Diffuser finish: Opal
- Driver Brand: MEANWELL
- Voltage / frequency: 100-240V/50-60Hz
- Dimming protocol: ON-OFF/DALI
- Power Factor: 0.90
- Useful life: 50,000h L80B20
- Warranty: 5 años



Luminotechnic features

- Luminance C0°G65°: 1377
- Luminance C90°G65°: 1377
- CRI: 90

UGR		Lampholder	Quantity	Light source power (W)	Correlated Colour Temperature (CCT)
S=0.250					
Ceiling / cavity	0.7	LED	1	49.6W	LED neutral-white 4000K
Walls	0.5				
Working Plane	0.2				
Room dimensions	X=4H, Y=8H				
UGR crosswise	18.8				
UGR lengthwise	18.8				

- Net weight (kg): 5
- Packaged weight (kg): 10
- Packaging: 981mm x 958mm x 95mm

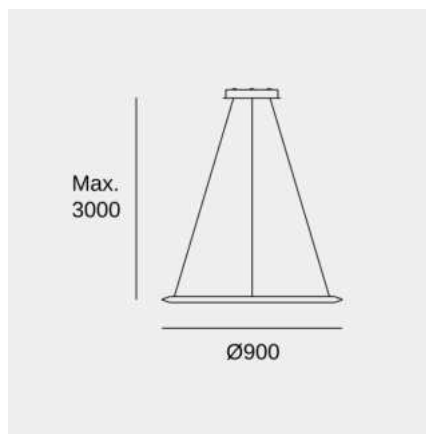
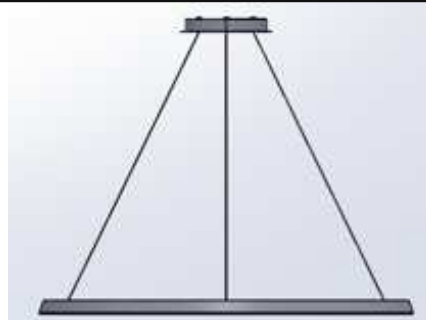

Image may not match reference. LedsC4 reserves the right to amend any of the product's components. The data related to flux, power and colour temperature may be subject to changes made by the manufacturer.



Circular Outward ø1200 Surface

Benedito Design

Pendant Circular Outward ø1200 Surface LED 72 LED neutral-white 4000K ON-OFF Black 6116lm

Technical features

- Luminaire total power: 72W
- Real lumens: 6116
- Real lm/W: 85
- Correlated Colour Temperature (CCT): LED neutral-white 4000K
- UGR: <=19
- Structure finish: Black
- Diffuser material: Polycarbonate
- Diffuser finish: Opal
- Driver Brand: MEANWELL
- Voltage / frequency: 100-240V/50-60Hz
- Dimming protocol: ON-OFF/DALI
- Power Factor: 0.90
- Useful life: 50,000h L80B20
- Warranty: 5 años



Luminotechnic features

- Luminance C0°G65°: 1309
- Luminance C90°G65°: 1243
- CRI: 90

UGR		Lampholder	Quantity	Light source power (W)	Correlated Colour Temperature (CCT)
S=0.250					
Ceiling / cavity	0.7	LED	1	67.4W	LED neutral-white 4000K
Walls	0.5				
Working Plane	0.2				
Room dimensions	X=4H, Y=8H				
UGR crosswise	18.5				
UGR lengthwise	18.4				

- Net weight (kg): 6
- Packaged weight (kg): 13
- Packaging: 1290mm x 1256mm x 95mm

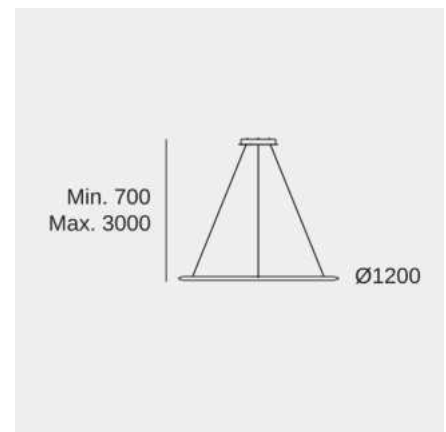

Image may not match reference. LedsC4 reserves the right to amend any of the product's components. The data related to flux, power and colour temperature may be subject to changes made by the manufacturer.



Circular Outward ø2000 Surface

Benedito Design

Pendant Circular Outward ø2000 Surface LED 129 LED neutral-white 4000K ON-OFF Black 10522lm

Technical features

- Luminaire total power: 129W
- Real lumens: 10522
- Real lm/W: 82
- Correlated Colour Temperature (CCT): LED neutral-white 4000K
- UGR: <=19
- Structure finish: Black
- Diffuser material: Polycarbonate
- Diffuser finish: Opal
- Driver Brand: MEANWELL
- Voltage / frequency: 100-240V/50-60Hz
- Dimming protocol: ON-OFF/DALI
- Power Factor: 0.90
- Useful life: 50,000h L80B20
- Warranty: 5 años



Luminotechnic features

- Luminance C0°G65°: 752
- Luminance C90°G65°: 714
- CRI: 90

UGR		Lampholder	Quantity	Light source power (W)	Correlated Colour Temperature (CCT)
S=0.250					
Ceiling / cavity	0.7	LED	1	123.2W	LED neutral-white 4000K
Walls	0.5				
Working Plane	0.2				
Room dimensions	X=4H, Y=8H				
UGR crosswise	16.7				
UGR lengthwise	16.5				

- Net weight (kg): 12
- Packaged weight (kg): 16
- Packaging: 1900mm x 650mm x 150mm

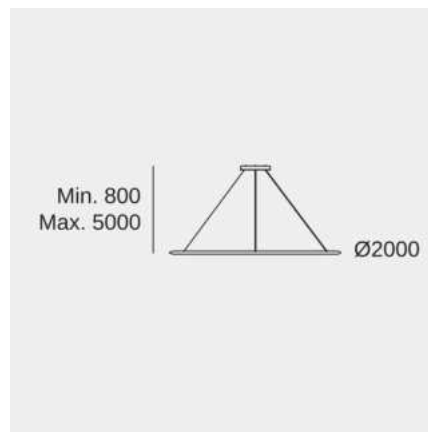
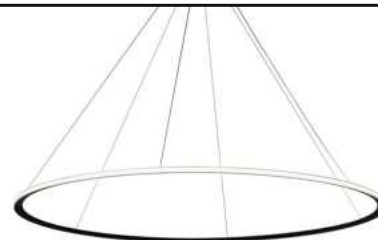

Image may not match reference. LedsC4 reserves the right to amend any of the product's components. The data related to flux, power and colour temperature may be subject to changes made by the manufacturer.



Circular Outward ø3000 Surface

Benedito Design

Pendant Circular Outward ø3000 Surface LED 190 LED neutral-white 4000K ON-OFF Black 15758lm

Technical features

- Luminaire total power: 190W
- Real lumens: 15758
- Real lm/W: 83
- Correlated Colour Temperature (CCT): LED neutral-white 4000K
- UGR: <=16
- Structure finish: Black
- Diffuser material: Polycarbonate
- Diffuser finish: Opal
- Driver Brand: MEANWELL
- Voltage / frequency: 100-240V/50-60Hz
- Dimming protocol: ON-OFF/DALI
- Power Factor: 0.90
- Useful life: 50,000h L80B20
- Warranty: 5 años



Luminotechnic features

- Luminance C0°G65°: 527
- Luminance C90°G65°: 501
- CRI: 90

UGR		Lampholder	Quantity	Light source power (W)	Correlated Colour Temperature (CCT)
S=0.250					
Ceiling / cavity	0.7	LED	1	180.8W	LED neutral-white 4000K
Walls	0.5				
Working Plane	0.2				
Room dimensions	X=4H, Y=8H				
UGR crosswise	15.5				
UGR lengthwise	15.3				

- Net weight (kg): 18
- Packaged weight (kg): 32
- Packaging: 2740mm x 1000mm x 255mm

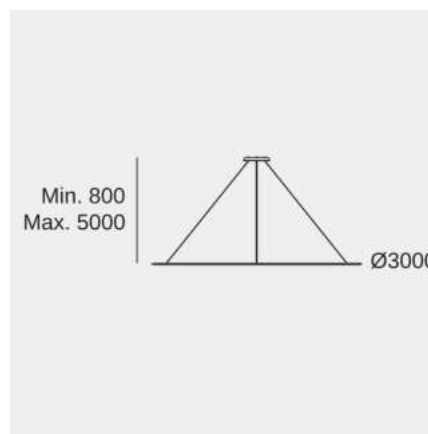
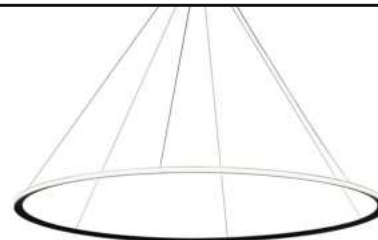

Image may not match reference. LedsC4 reserves the right to amend any of the product's components. The data related to flux, power and colour temperature may be subject to changes made by the manufacturer.