



Play IP65 Square Fixed

LedsC4 Team

Downlight Play IP65 Square Fixed 14.3 LED neutral-white 4000K CRI 90 34.2° ON-OFF Black IP65 1242lm

Technical features

- Luminaire total power: 14.3W
- Real lumens: 1242
- Real lm/W: 87
- Correlated Colour Temperature (CCT): LED neutral-white 4000K
- Lens / reflector angle: MEDIUM 34°
- UGR: <=19
- Structure material: Aluminium
- Structure finish: Black
- Diffuser material: Glass
- Diffuser finish: Transparent
- Driver Brand: VOSSLOH-SCHWABE
- Voltage / frequency: 100-240V/50-60Hz
- Dimming protocol: ON-OFF
- Power Factor: 0.88
- Useful life: 50,000h L80B20
- Warranty: 5 años
- Easily recyclable luminaire



Luminotechnic features

- CRI: 90
- MacAdam steps: 2
- Photobiological risk: RG2

UGR		Lampholder	Quantity	Light source power (W)	Correlated Colour Temperature (CCT)
S=0.250					
Ceiling / cavity	0.7	LED	1	11.9W	LED neutral-white 4000K
Walls	0.5				
Working Plane	0.2				
Room dimensions	X=4H, Y=8H				
UGR crosswise	18.1				
UGR lengthwise	18.1				

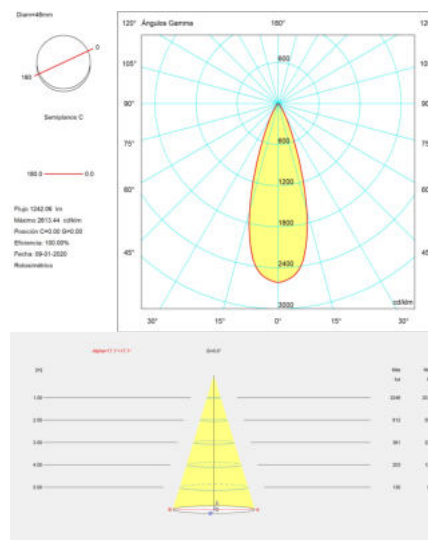
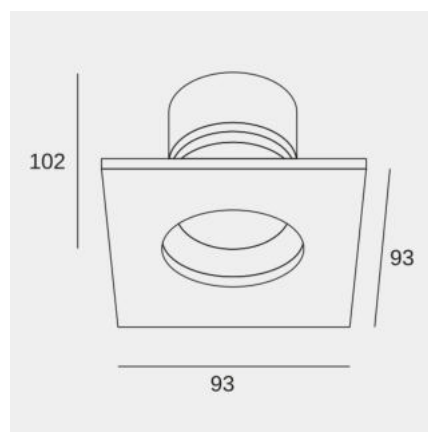
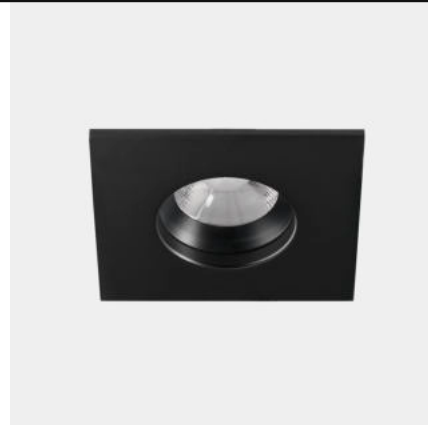

Image may not match reference. LedsC4 reserves the right to amend any of the product's components. The data related to flux, power and colour temperature may be subject to changes made by the manufacturer.



Play IP65 Square Fixed

LedsC4 Team

Downlight Play IP65 Square Fixed 14.3 LED neutral-white 4000K CRI 90 34.2° ON-OFF Black IP65 1242lm

Logistics



Net weight (kg): 0.38

Packaged weight (kg): 0.45

Packaging: 170mm x 120mm x 120mm

Image may not match reference. LedsC4 reserves the right to amend any of the product's components. The data related to flux, power and colour temperature may be subject to changes made by the manufacturer.



Play IP65 Square Fixed

LedsC4 Team

Downlight Play IP65 Square Fixed 14.3 LED neutral-white 4000K CRI 90 34.2° ON-OFF Black IP65 1242lm

Optional accessories



71-4754-14-00

White visual comfort

Structure material: Polycarbonate
Dimensions: 52 x NA x 27
Net weight (kg): 0.01



71-4754-60-00

Black visual comfort

Structure material: ABS
Dimensions: 52 x NA x 26
Net weight (kg): 0.01

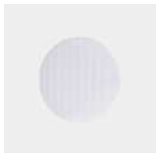

71-5167-00-00

5 x Elliptical diffuser

Structure material: Polycarbonate
Dimensions: NA x NA x NA
Net weight (kg): 0.01

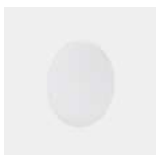

71-5658-00-00

5 x Square diffuser

Structure material: Polycarbonate
Dimensions: 47 x NA x 2
Net weight (kg): 0.08

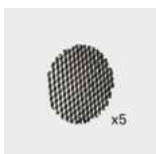

71-5166-60-00

5 x Honeycomb panel

Structure material: Aluminium
Dimensions: NA x NA x NA
Net weight (kg): 0.01

Image may not match reference. LedsC4 reserves the right to amend any of the product's components. The data related to flux, power and colour temperature may be subject to changes made by the manufacturer.

Optional accessories

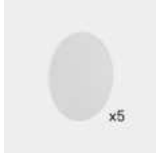

71-6099-00-00

5 x Halo diffuser

Structure material: Methacrylate

Dimensions: 47 x NA x 2

Net weight (kg): 0.01

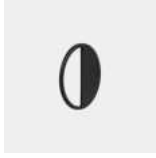

71-7895-60-00

5 x Screen

Structure material: Steel

Dimensions: 46 x NA x 2

Net weight (kg): 0.09

Image may not match reference. LedsC4 reserves the right to amend any of the product's components. The data related to flux, power and colour temperature may be subject to changes made by the manufacturer.