



Play Deco Asymmetrical Round Fixed

LedsC4 Team

Downlight Play Deco Asymmetrical Round Fixed 14.3 LED neutral-white 4000K CRI 90 33.2° ON-OFF Black/Black IP54 1171lm

Technical features

- Luminaire total power: 14.3W
- Real lumens: 1171
- Real lm/W: 82
- Correlated Colour Temperature (CCT): LED neutral-white 4000K
- Lens / reflector angle: MEDIUM 32°
- Structure material: Polycarbonate, Aluminium
- Structure finish: Black/Black
- Diffuser material: Methacrylate
- Diffuser finish: Transparent
- Driver Brand: VOSSLOH-SCHWABE
- Voltage / frequency: 100-240V/50-60Hz
- Dimming protocol: ON-OFF
- Power Factor: 0.88
- Useful life: 50,000h L80B20
- Warranty: 5 años



Luminotechnic features

- Luminance C0°G65°: 445
- CRI: 90
- MacAdam steps: 2
- Photobiological risk: RG2

Lampholder	Quantity	Light source power (W)	Correlated Colour Temperature (CCT)
LED	1	11.9W	LED neutral-white 4000K

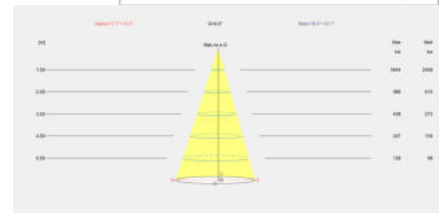
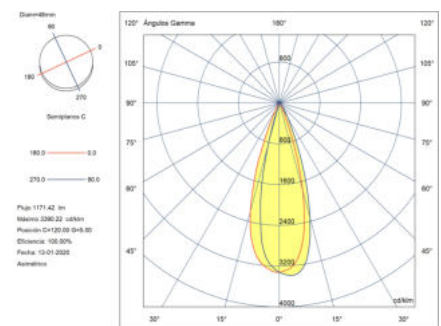
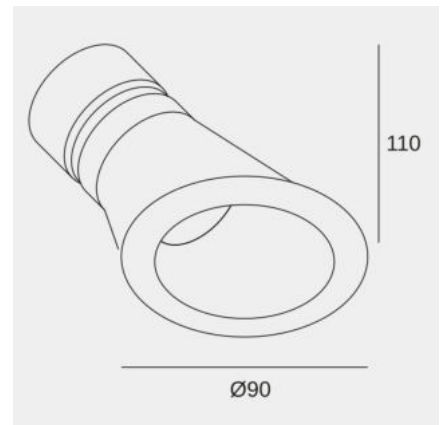
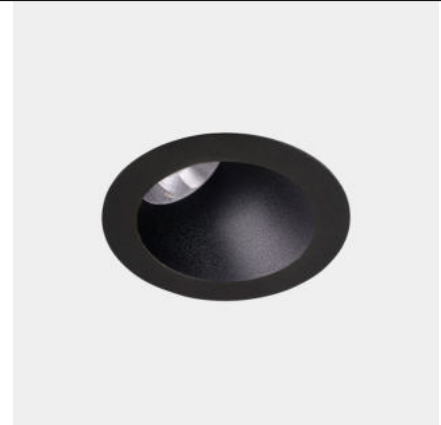

Image may not match reference. LedsC4 reserves the right to amend any of the product's components. The data related to flux, power and colour temperature may be subject to changes made by the manufacturer.



Play Deco Asymmetrical Round Fixed Trimless

LedsC4 Team

Downlight Play Deco Asymmetrical Round Fixed Trimless 14.3 LED neutral-white 4000K CRI 90 33.2° ON-OFF Trimless/Black IP54 1171lm

Optional accessories



71-4754-14-00

White visual comfort

Structure material: Polycarbonate
Dimensions: 52 x NA x 27
Net weight (kg): 0.01



71-4754-60-00

Black visual comfort

Structure material: ABS
Dimensions: 52 x NA x 26
Net weight (kg): 0.01

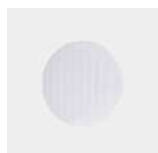

71-5167-00-00

5 x Elliptical diffuser

Structure material: Polycarbonate
Dimensions: NA x NA x NA
Net weight (kg): 0.01

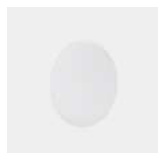

71-5658-00-00

5 x Square diffuser

Structure material: Polycarbonate
Dimensions: 47 x NA x 2
Net weight (kg): 0.08



71-5166-60-00

5 x Honeycomb panel

Structure material: Aluminium
Dimensions: NA x NA x NA
Net weight (kg): 0.01

Image may not match reference. LedsC4 reserves the right to amend any of the product's components. The data related to flux, power and colour temperature may be subject to changes made by the manufacturer.

Optional accessories

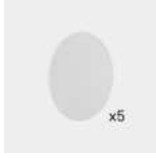

71-6099-00-00

5 x Halo diffuser

Structure material: Methacrylate

Dimensions: 47 x NA x 2

Net weight (kg): 0.01

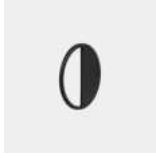

71-7895-60-00

5 x Screen

Structure material: Steel

Dimensions: 46 x NA x 2

Net weight (kg): 0.09

Image may not match reference. LedsC4 reserves the right to amend any of the product's components. The data related to flux, power and colour temperature may be subject to changes made by the manufacturer.