

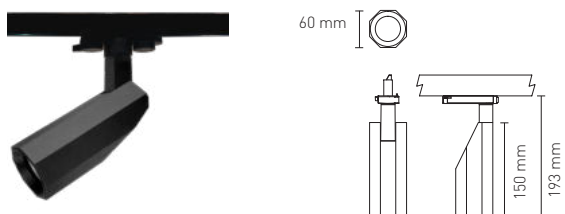

NEXIA

MOON

MOON is available in different sizes and with the possibility of incorporating its accessory lenses to personalize the function of the light.



06901 -		MOON SPOTLIGHTS 60 mm								
Colour	CRI / Temp.	Angle	Led	Regulation	Class					
0 White	H 927	1 12°	1 1030 lm / 9 W	R Edge cut	I					
1 Black	E 930	2 24°								
	F 940	3 38°								

690 g	90°	355°	1	IP 20	CRI=90	3-SDCM	50.000 h	230 V	DRIVER	LED	Track adaptor
-------	-----	------	---	-------	--------	--------	----------	-------	--------	-----	---------------

ACCESSORIES

06991 - SCULPTURE LENS 16 x 60°

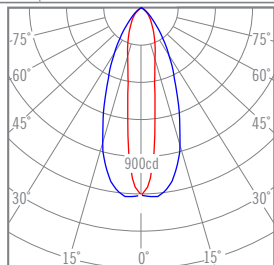

cd / Kl/m $\eta=54\%$
 - c0 - 180 - c90 - 270

06992 - LENS "SQUARE"

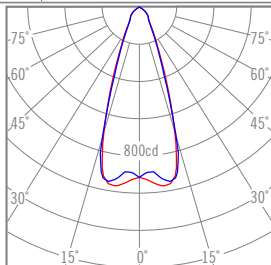

cd / Kl/m $\eta=59\%$
 - c0 - 180 - c90 - 270

06993 - MOON60 HONEYCOMB



12°

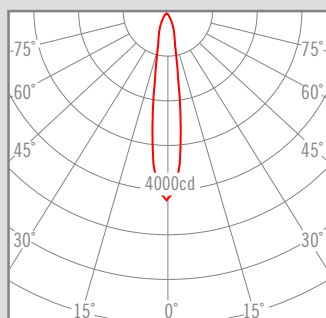

cd / Kl/m $\eta=65\%$
 - c0 - 180 - c90 - 270

24°

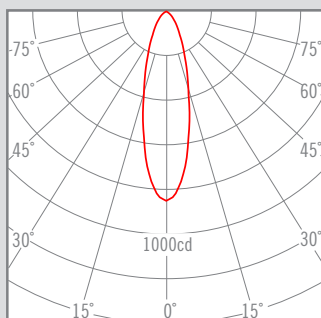

cd / Kl/m $\eta=54\%$
 - c0 - 180 - c90 - 270

38°

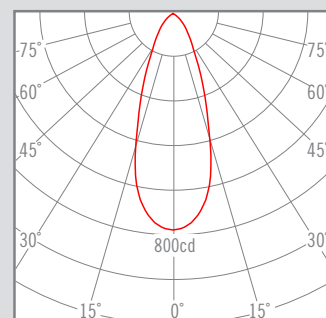

cd / Kl/m $\eta=56\%$
 - c0 - 180 - c90 - 270

QUALITY CERTIFICATES:

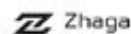



NEXIA

MOON

MOON is available in different sizes and with the possibility of incorporating its accessory lenses to personalize the function of the light.

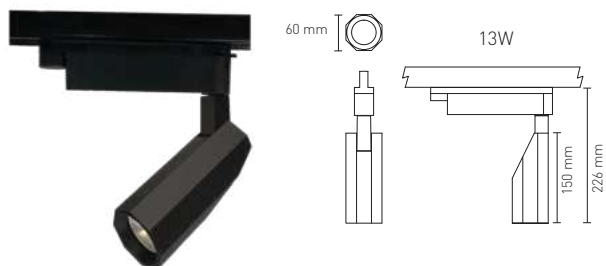

06902 -		MOON SPOTLIGHTS 60 mm				
Colour	CRI / Temp.	Angle	Led	Regulation	Class	
0 White	H 927	1 12°	2 1330 lm / 13 W	R Edge cut	I	
1 Black	E 930	2 24°				
	F 940	3 38°				

910 g	90°	355°	1	IP 20	CRI=90	3-SDCM	50.000 h	230 V	DRIVER	LED	Track adaptor
-------	-----	------	---	-------	--------	--------	----------	-------	--------	-----	---------------

ACCACCESSORIES

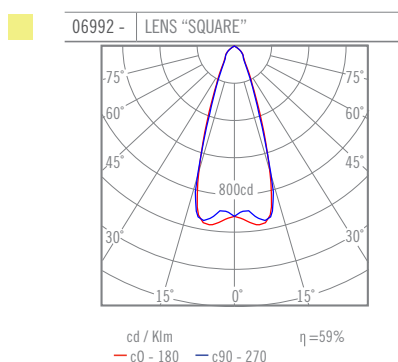
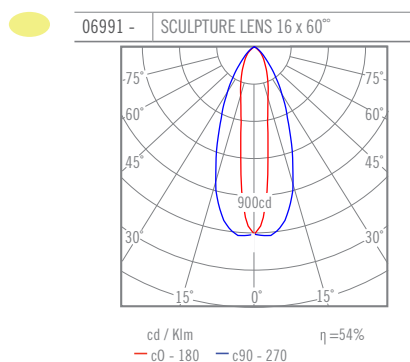

06993 - MOON60 HONEYCOMB

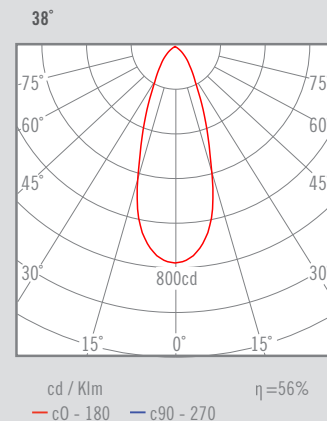
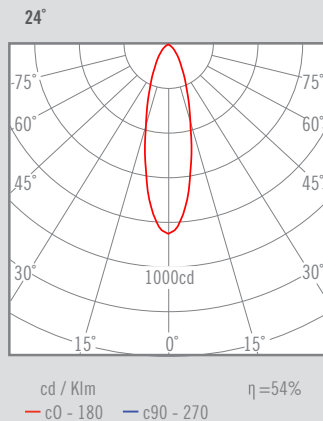
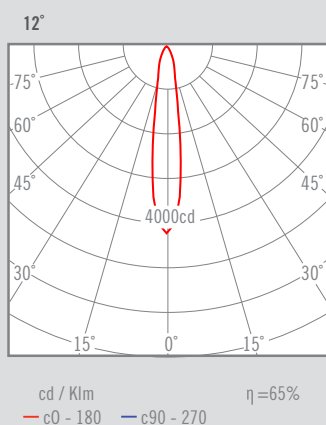

QUALITY CERTIFICATES:

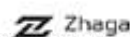



NEXIA

MOON

MOON is available in different sizes and with the possibility of incorporating its accessory lenses to personalize the function of the light.

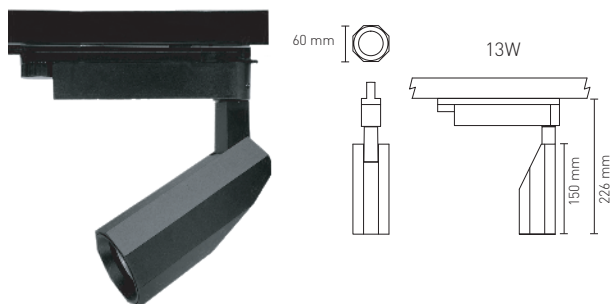

06903 - MOON SPOTLIGHTS 60 mm						
Colour	CRI / Temp.	Angle	Led	Regulation	Class	
0 White	H 927	1 12°	2 1330 lm / 13 W	D Dali	I	
1 Black	E 930	2 24°				
	F 940	3 38°				

930 g	90°	355°	1	20	CRI=90	3-SDCM	50.000 h	230 V	DRIVER	LED	Track adaptor
-------	-----	------	---	----	--------	--------	----------	-------	--------	-----	---------------

ACCACCESSORIES

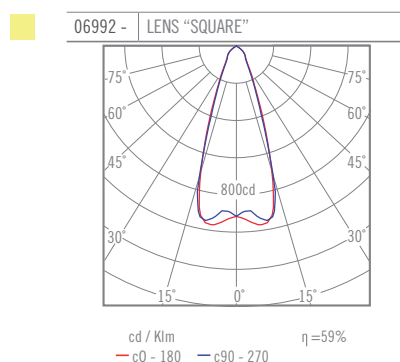
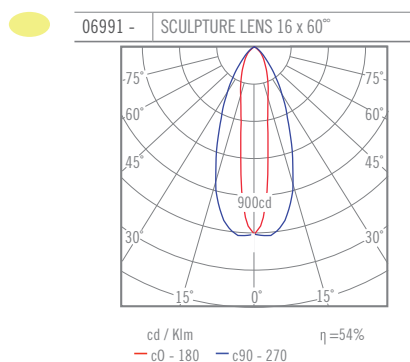

06993 - MOON60 HONEYCOMB

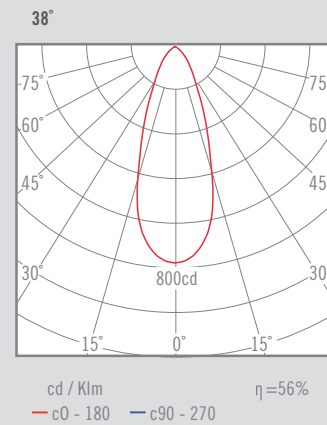
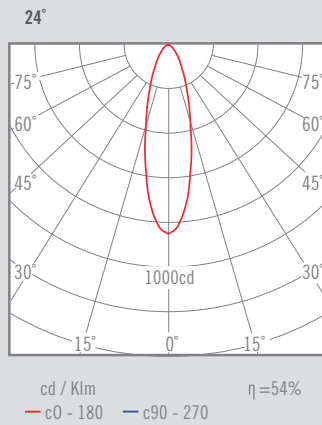
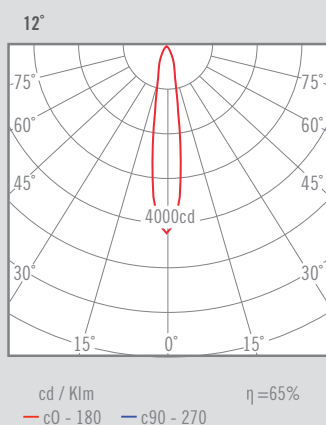

QUALITY CERTIFICATES:





NEXIA

MOON

MOON is available in different sizes and with the possibility of incorporating its accessory lenses to personalize the function of the light.

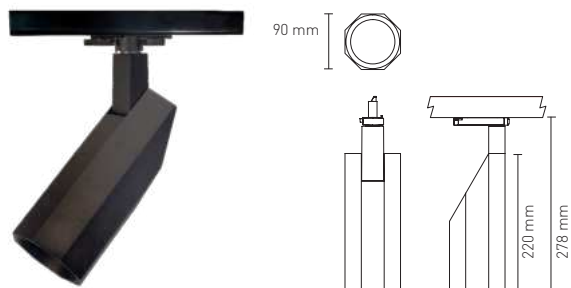

06911 -		MOON SPOTLIGHTS 90 mm				
Colour	CRI / Temp.	Angle	Led	Regulation	Class	
0 White	G 827	1 12°	2 1500 lm / 12 W	D Dali	I	
1 Black	C 830	2 24°	3 2000 lm / 17,5 W			
	N 840	3 38°	4 3000 lm / 25 W			
	H 927					
	E 930					
	F 940					

1190 g	90°	355°	1	IP 20	CRI=80/90	2-SDCM	50.000h	230V	DRIVER <5%	LED	Track adaptor
--------	-----	------	---	-------	-----------	--------	---------	------	------------	-----	---------------

ACCESORIOS

06993 - MOON90 HONEYCOMB



06995 SCULPTURE LENS 16 x 60°

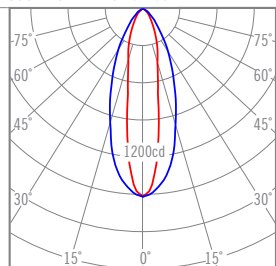

cd / Kl/m $\eta=69\%$
 - c0 - 180 - c90 - 270



12°

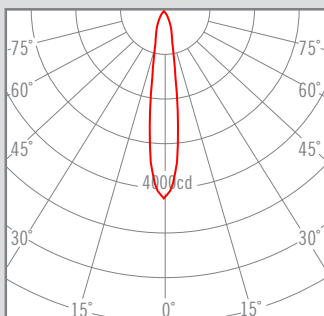

cd / Kl/m $\eta=81\%$
 - c0 - 180 - c90 - 270

06996 LENS WALLWASHER

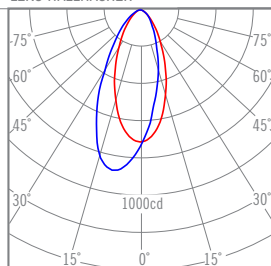

cd / Kl/m $\eta=64\%$
 - c0 - 180 - c90 - 270



24°

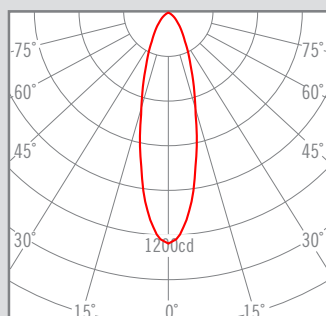

cd / Kl/m $\eta=75\%$
 - c0 - 180 - c90 - 270

06997 LENS "SQUARE"

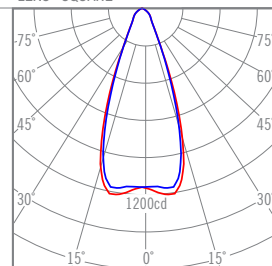

cd / Kl/m $\eta=74\%$
 - c0 - 180 - c90 - 270



38°

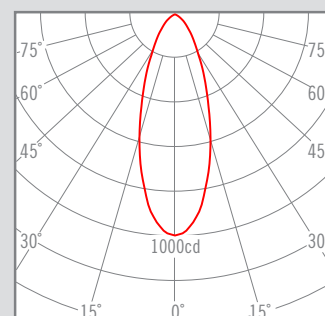

cd / Kl/m $\eta=73\%$
 - c0 - 180 - c90 - 270

QUALITY CERTIFICATES:

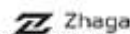



NEXIA

MOON

MOON is available in different sizes and with the possibility of incorporating its accessory lenses to personalize the function of the light.

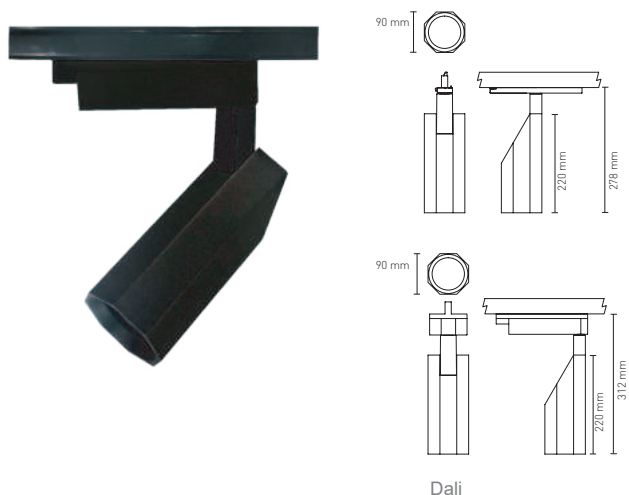

06912 - MOON SPOTLIGHTS 90 mm						
Colour	CRI / Temp.	Angle	Led	Regulation	Class	
0 White	G 827	1 12°	2 1500 lm / 12 W	D Dali	I	
1 Black	C 830	2 24°	3 2000 lm / 17,5 W			
	N 840	3 38°	4 3000 lm / 25 W			
	H 927					
	E 930					
	F 940					

1420 g 90° 355° 1 IP 20 CRI=80/90 2-SDCM 50.000 h 230 V DRIVER <5% LED Track adaptor

ACCESSORIES

06998 - MOON90 HONEYCOMB

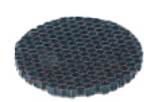

06995 SCULPTURE LENS 16 x 60°

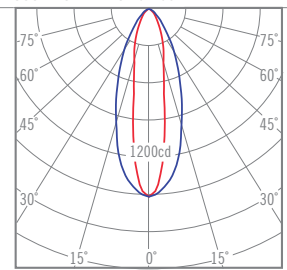

cd / Kl/m η=69%
- c0 - 180 - c90 - 270

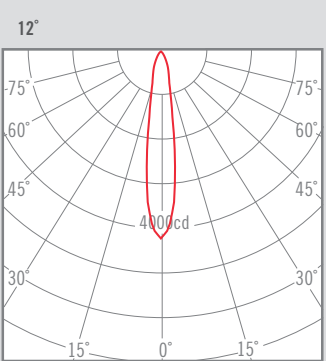

cd / Kl/m η=81%
- c0 - 180 - c90 - 270

06996 LENS WALLWASHER

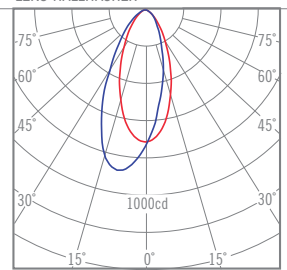

cd / Kl/m η=64%
- c0 - 180 - c90 - 270

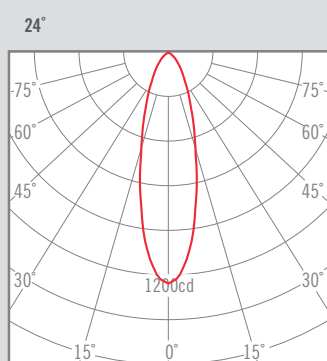
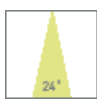

cd / Kl/m η=75%
- c0 - 180 - c90 - 270

06997 LENS "SQUARE"

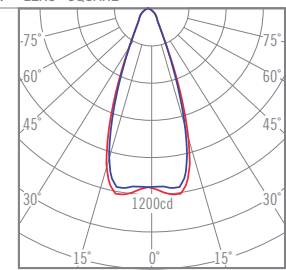

cd / Kl/m η=74%
- c0 - 180 - c90 - 270

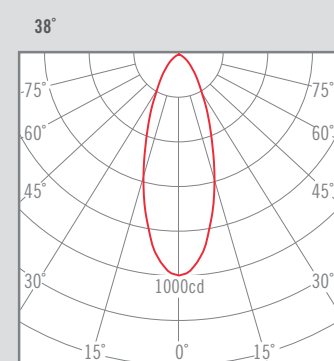
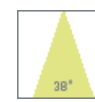

cd / Kl/m η=73%
- c0 - 180 - c90 - 270

QUALITY CERTIFICATES:

