

# TIRES

by  
Nahtrang Design

EN  
The perfect balance between design, technicity and warmness. It allows your personalization by playing with the multiple finishes and shapes available. This family includes the sustainable acoustic panel to absorb the acoustic pollution of the space.

ES  
TIRES es la mezcla perfecta entre diseño, tecnicidad y calidez. Permite su completa personalizacion jugando con los múltiples acabados y formas disponibles. Esta familia cuenta con el panel acústico eco sostenible para amortiguar la contaminación acústica del espacio.

FR  
TIRES est le mélange parfait entre le design, la technicité et la chaleur. Permet une complète personnalisation en jouant avec les multiples finitions et les formes disponibles. Cette famille compte avec un panneau acoustique écologique pour atténuer la pollution sonore dans l'espace.

IT  
TIRES è un mix perfetto tra design, tecnicità e prossimità. Permette una completa personalizzazione grazie alla varietà di finiture e forme disponibili. Una famiglia disponibile anche con il pannello fonoassorbente eco sostenibile per attutire i rumori ambientali.

# TIRES

by  
Nahtrang Design

## Technical information / Información técnica:

Index Protection / Índice de protección:	IP20
Driver:	Included / Incluido
CRI:	90
Temperature / Temperatura:	2700K / 3000K
Lifetime / Tiempo de vida:	50.000h
Technology / Tecnología:	LED
Guarantee / Garantía:	5 years / 5 años
Class I / Clase I	
Voltage / Voltaje:	230V*

\* Consult for 120V / Consultar para 120V

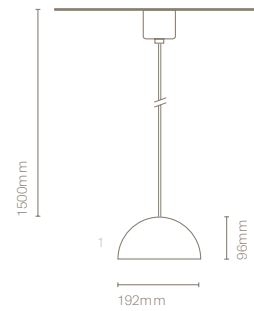

Tires Model 1  
31310-

## Model:

	COLOUR CUPOLA	CRI/TEMP.	LED
● M	Grey blue	H 927	1 1300lm/12W
● J	Cement grey	E 930	
● E	Silk grey		
● S	Red oxide		

## Collection:



Tires Model 1  
31310-

Tires Model 4  
31340-

Tires Model 2  
31320-

Tires Model 3  
31330-

Tires Model 5 Acoustic  
31350-

Quality certificates:



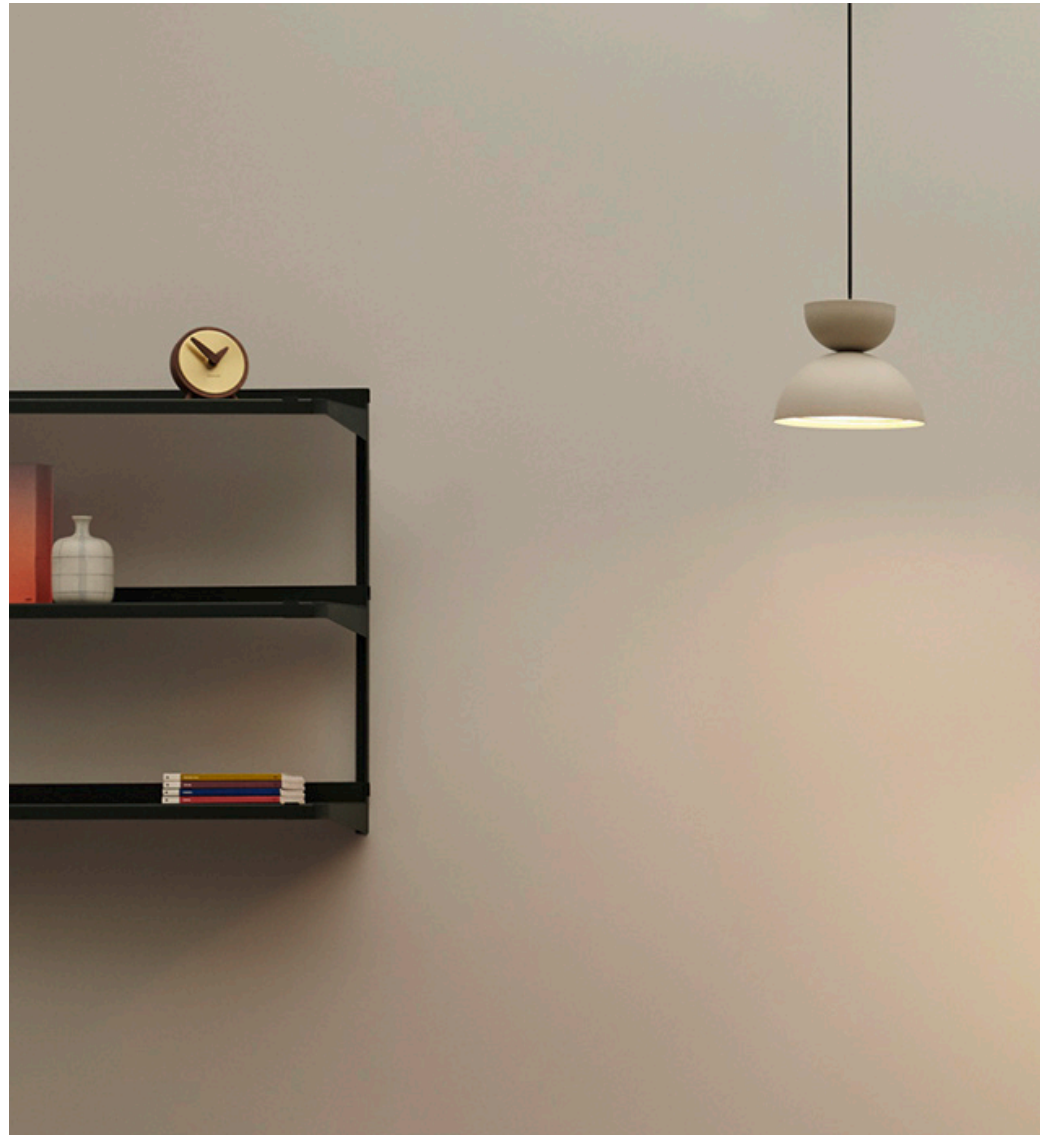

## TIRES

by  
Nahtrang Design

**EN**  
The perfect balance between design, technicity and warmness. It allows your personalization by playing with the multiple finishes and shapes available. This family includes the sustainable acoustic panel to absorb the acoustic pollution of the space.

**ES**  
TIRES es la mezcla perfecta entre diseño, tecnicidad y calidez. Permite su completa personalizacion jugando con los múltiples acabados y formas disponibles. Esta familia cuenta con el panel acústico eco sostenible para amortiguar la contaminación acústica del espacio.

**FR**  
TIRES est le mélange parfait entre le design, la technicité et la chaleur. Permet une complète personnalisation en jouant avec les multiples finitions et les formes disponibles. Cette famille compte avec un panneau acoustique écologique pour atténuer la pollution sonore dans l'espace.

**IT**  
TIRES è un mix perfetto tra design, tecnicità e prossimità. Permette una completa personalizzazione grazie alla varietà di finiture e forme disponibili. Una famiglia disponibile anche con il pannello fonoassorbente eco sostenibile per attutire i rumori ambientali.

# TIRES

by  
Nahrang Design

## Technical information / Información técnica:

Index Protection / Índice de protección:	IP20
Driver:	Included / Incluido
CRI:	90
Temperature / Temperatura:	2700K / 3000K
Lifetime / Tiempo de vida:	50.000h
Technology / Tecnología:	LED
Guarantee / Garantía:	5 years / 5 años
Class I / Clase I	
Voltage / Voltaje:	230V*

\* Consult for 120V / Consultar para 120V

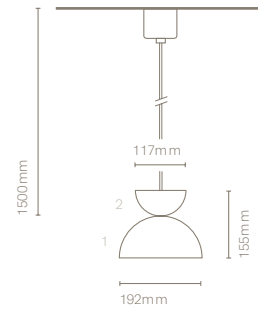

Tires Model 2  
31320-

## Model:

	COLOUR CUPOLA 1	COLOUR CUPOLA 2	CRI/TEMP.	LED
● M Grey blue	M Grey blue	M Grey blue	H 927	1 1300lm/12W
● J Cement grey	J Cement grey	J Cement grey	E 930	
● E Silk grey	E Silk grey	E Silk grey		
● S Red oxide	S Red oxide	S Red Oxide		

## Collection:



Tires Model 1  
31310-

Tires Model 4  
31340-

Tires Model 2  
31320-

Tires Model 3  
31330-

Tires Model 5 Acoustic  
31350-

Quality certificates:





## TIRES

by  
Nahtrang Design

EN  
The perfect balance between design, technicity and warmness. It allows your personalization by playing with the multiple finishes and shapes available. This family includes the sustainable acoustic panel to absorb the acoustic pollution of the space.

ES  
TIRES es la mezcla perfecta entre diseño, tecnicidad y calidez. Permite su completa personalizacion jugando con los múltiples acabados y formas disponibles. Esta familia cuenta con el panel acústico eco sostenible para amortiguar la contaminación acústica del espacio.

FR  
TIRES est le mélange parfait entre le design, la technicité et la chaleur. Permet une complète personnalisation en jouant avec les multiples finitions et les formes disponibles. Cette famille compte avec un panneau acoustique écologique pour atténuer la pollution sonore dans l'espace.

IT  
TIRES è un mix perfetto tra design, tecnicità e prossimità. Permette una completa personalizzazione grazie alla varietà di finiture e forme disponibili. Una famiglia disponibile anche con il pannello fonoassorbente eco sostenibile per attutire i rumori ambientali.

# TIRES

by  
Nahrang Design

## Technical information / Información técnica:

Index Protection / Índice de protección:	IP20
Driver:	Included / Incluido
CRI:	90
Temperature / Temperatura:	2700K / 3000K
Lifetime / Tiempo de vida:	50.000h
Technology / Tecnología:	LED
Guarantee / Garantía:	5 years / 5 años
Class I / Clase I	
Voltage / Voltaje:	230V*

\* Consult for 120V / Consultar para 120V

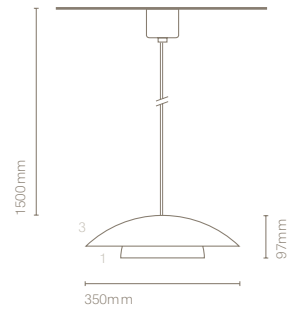

Tires Model 3  
31330-

## Model:

31330-	COLOUR CUPOLA 1	COLOUR CUPOLA 3	CRI/TEMP.	LED
●	M Grey blue	M Grey blue	H 927	1 1300lm/12W
●	J Cement grey	J Cement grey	E 930	
●	E Silk grey	E Silk grey		
●	S Red oxide	S Red Oxide		

## Collection:



Tires Model 1  
31310-

Tires Model 4  
31340-

Tires Model 2  
31320-

Tires Model 3  
31330-

Tires Model 5 Acoustic  
31350-

Quality certificates:





# TIRES

by  
Nahtrang Design

EN  
The perfect balance between design, technicity and warmness. It allows your personalization by playing with the multiple finishes and shapes available. This family includes the sustainable acoustic panel to absorb the acoustic pollution of the space.

ES  
TIRES es la mezcla perfecta entre diseño, tecnicidad y calidez. Permite su completa personalizacion jugando con los múltiples acabados y formas disponibles. Esta familia cuenta con el panel acústico eco sostenible para amortiguar la contaminación acústica del espacio.

FR  
TIRES est le mélange parfait entre le design, la technicité et la chaleur. Permet une complète personnalisation en jouant avec les multiples finitions et les formes disponibles. Cette famille compte avec un panneau acoustique écologique pour atténuer la pollution sonore dans l'espace.

IT  
TIRES è un mix perfetto tra design, tecnicità e prossimità. Permette una completa personalizzazione grazie alla varietà di finiture e forme disponibili. Una famiglia disponibile anche con il pannello fonoassorbente eco sostenibile per attutire i rumori ambientali.

# TIRES

by  
Nahrang Design

## Technical information / Información técnica:

Index Protection / Índice de protección:	IP20
Driver:	Included / Incluido
CRI:	90
Temperature / Temperatura:	2700K / 3000K
Lifetime / Tiempo de vida:	50.000h
Technology / Tecnología:	LED
Guarantee / Garantía:	5 years / 5 años
Class I / Clase I	
Voltage / Voltaje:	230V*

\* Consult for 120V / Consultar para 120V

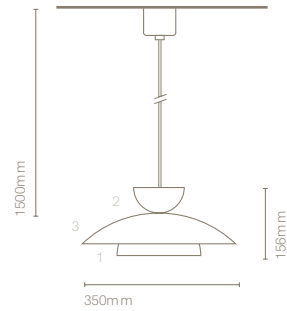

Tires Model 4  
31340-

## Model:

31340-	COLOUR CUPOLA 1	COLOUR CUPOLA 2	COLOUR CUPOLA 3	CRI/TEMP.	LED
●	M Grey blue	M Grey blue	M Grey blue	H 927	1 1300lm/12W
●	J Cement grey	J Cement grey	J Cement grey	E 930	
●	E Silk grey	E Silk grey	E Silk grey		
●	S Red oxide	S Red Oxide	S Red Oxide		

## Collection:



Tires Model 1  
31310-

Tires Model 4  
31340-

Tires Model 2  
31320-

Tires Model 3  
31330-

Tires Model 5 Acoustic  
31350-

Quality certificates:

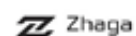





## TIRES

by  
Nahtrang Design

**EN**  
The perfect balance between design, technicity and warmness. It allows your personalization by playing with the multiple finishes and shapes available. This family includes the sustainable acoustic panel to absorb the acoustic pollution of the space.

**ES**  
TIRES es la mezcla perfecta entre diseño, tecnicidad y calidez. Permite su completa personalización jugando con los múltiples acabados y formas disponibles. Esta familia cuenta con el panel acústico eco sostenible para amortiguar la contaminación acústica del espacio.

**FR**  
TIRES est le mélange parfait entre le design, la technicité et la chaleur. Permet une complète personnalisation en jouant avec les multiples finitions et les formes disponibles. Cette famille compte avec un panneau acoustique écologique pour atténuer la pollution sonore dans l'espace.

**IT**  
TIRES è un mix perfetto tra design, tecnicità e prossimità. Permette una completa personalizzazione grazie alla varietà di finiture e forme disponibili. Una famiglia disponibile anche con il pannello fonoassorbente eco sostenibile per attutire i rumori ambientali.

# TIRES

by  
Nahtrang Design

## Technical information / Información técnica:

Index Protection / Índice de protección:	IP20
Driver:	Included / Incluido
CRI:	90
Temperature / Temperatura:	2700K / 3000K
Lifetime / Tiempo de vida:	50.000h
Technology / Tecnología:	LED
Guarantee / Garantía:	5 years / 5 años
Class I / Clase I	
Voltage / Voltaje:	230V*

\* Consult for 120V / Consultar para 120V

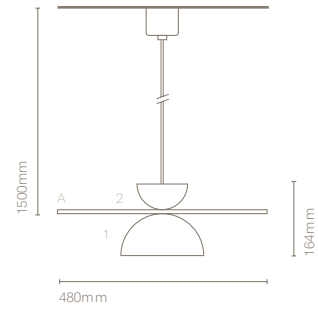

Tires Model 5 Acoustic  
31350-

## Model:

31350-	COLOUR CUPOLA 1	COLOUR CUPOLA 2	COLOUR ACOUSTIC	CRI/TEMP.	LED
●	M Grey blue	M Grey blue	● S Silver grey	H 927	1 1300lm/12W
●	J Cement grey	J Cement grey	● A Anthracite	E 930	
●	E Silk grey	E Silk grey	● D Dark camel		
●	S Red oxide	S Red oxide			

## Collection:



Tires Model 1  
31310-

Tires Model 4  
31340-

Tires Model 2  
31320-

Tires Model 3  
31330-

Tires Model 5 Acoustic  
31350-

Quality certificates:

